



# **DC20 Lifting Column**

## **Installation Instructions**

**(Translation of the original installation instructions)**



# Foreword

## Document revision history

| Version | Date    | Modification, change |
|---------|---------|----------------------|
| 1.0     | 12/2019 | First release        |

## Disclaimer and exclusion of liability

DewertOkin is not responsible for damage resulting from:

- failure to observe these instructions,
- changes made to this product which have not been approved by DewertOkin, or
- the use of replacement parts which have not been approved or manufactured by DewertOkin.

## Manufacturer's address

DewertOkin GmbH  
Weststrasse 1  
32278 Kirchlegern, Germany  
Germany  
Tel: +49 (0)5223/979-0  
Fax.: +49 (0)5223/75182  
<http://www.dewertokin.de>  
[Info@dewertokin.de](mailto:Info@dewertokin.de)

## Creation of a complete operating instruction manual for the entire end product

These instructions are only intended to be used by the end-product manufacturer. They should not be given to the operator of the end product. The factual information contained within may be used as a basis when creating the end-product manual.

The warning and danger notices are best suited for use in the end product's manual. However, it is not sufficient to simply follow these notices. You should also carry out an internal risk assessment for your end product. This can then be used as the basis for the safety notices in your manual.

These installation instructions do not contain all information required to safely operate the end product. They only describe the installation and operation of the lifting column as partially completed machinery.

The instructions are intended for the technicians responsible for manufacturing an end product and not for the operators of the end product.



# Table of Contents

|  |           |
|--|-----------|
| <b>Foreword</b>  | <b>3</b>  |
| Document revision history  | 3         |
| Disclaimer and exclusion of liability  | 3         |
| Manufacturer's address   | 3         |
| Creation of a complete operating instruction manual for the entire end product                               | 3         |
| <br>   |           |
| <b>Table of Contents</b>   | <b>5</b>  |
| <br>   |           |
| <b>1. General Information</b>  | <b>7</b>  |
| 1.1 About these installation instructions  | 7         |
| 1.2 Availability of this document  | 7         |
| 1.3 Conventions used   | 8         |
| <br>   |           |
| <b>2. Safety notices</b>   | <b>9</b>  |
| 2.1 Proper and intended usage  | 9         |
| 2.2 Safety notices within the installation instruction and the operating instructions for the entire machine | 10        |
| 2.3 Selection and qualification of personnel   | 10        |
| 2.4 Notice on safety during operations   | 11        |
| 2.5 Product identification   | 12        |
| <br>   |           |
| <b>3. Possible combinations</b>  | <b>13</b> |
| <br>   |           |
| <b>4. Description</b>  | <b>14</b> |
| 4.1 Components   | 14        |
| <br>   |           |
| <b>5. Technical specifications</b>   | <b>16</b> |
| <br>   |           |
| <b>6. Installation</b>   | <b>18</b> |
| 6.1 Safety notices to observe during installation  | 18        |
| 6.2 Installation procedure   | 19        |
| <br>   |           |
| <b>7. Operating notes</b>  | <b>23</b> |
| 7.1 General information  | 23        |
| <br>   |           |
| <b>8. Troubleshooting</b>  | <b>25</b> |
| <br>   |           |
| <b>9. Maintenance</b>  | <b>26</b> |
| 9.1 Maintenance  | 26        |
| 9.2 Cleaning and care  | 27        |
| <br>   |           |
| 92299 1.0  | 5         |



|             |  |           |
|-------------|--|-----------|
| <b>10.</b>  | <b>Disposal</b>                                  | <b>28</b> |
| <b>10.1</b> | <b>Packaging material</b>                        | <b>28</b> |
| <b>10.2</b> | <b>Components of the lifting column</b>          | <b>28</b> |
|             | <b>Declaration of incorporation/installation</b> | <b>29</b> |
|             | <b>EU Declaration of Conformity</b>              | <b>30</b> |
|             | <b>Additional information</b>                    | <b>31</b> |

# 1. General Information

## 1.1 About these installation instructions

These installation instructions must be followed closely in order to install the DC20 lifting column successfully and safely in the end product. These instructions are not an operating manual for the end product.

These instructions will help you to minimize danger, repair costs and down times. They will also help you to maximize the reliability and lifespan of the end product.

|   |  |
|---|--|
|  | <p data-bbox="411 622 608 678"> <b>CAUTION</b></p> <p data-bbox="411 696 1422 759">The notices in these instructions must be followed! Following the guidelines during installation and connection procedures will help to minimize:</p> <ul data-bbox="411 772 1007 846" style="list-style-type: none"><li>• the risk of accident and injury, and</li><li>• damage to the drive system or the end product.</li></ul> |
|---|--|

These installation instructions have been written with due care and attention. However, we cannot guarantee that the data, images and drawings are complete and correct nor do we accept any liability for the information contained therein, unless required by law.

► We reserve the right to make unannounced technical changes in the course of our continual product improvement process!

## 1.2 Availability of this document





As manufacturer of the end product, you are obligated to comply with Machinery Directive 2006/42/EC. This directive stipulates that the installation instructions must be kept on file for governmental inspection purposes.

### 1.3 Conventions used

Notices which do not relate to safety are indicated in these instructions with a triangle:

- ▶ Triangular notice symbol

#### Safety notice explanations

|   |  |
|---|--|
|    | <div style="background-color: #FF8C00; padding: 2px;"><b> WARNING</b></div> <p>WARNING indicates a hazardous situation which, if not avoided, <i>could</i> result in death or serious injury.</p> |
|    | <div style="background-color: #FFFF00; padding: 2px;"><b> CAUTION</b></div> <p>CAUTION indicates a hazardous situation which, if not avoided, could result in minor or moderate injury.</p>       |
|  | <div style="background-color: #0056B3; color: white; padding: 2px;"><b>NOTICE</b></div> <p>NOTICE is used to address practices which are not related to personal injury but may result in damage to the product or surroundings.</p>   |





## 2. Safety notices

### 2.1 Proper and intended usage



The DC20 lifting column is designed to be installed in end products:



- It provides motor adjustment capabilities for movable furniture. It should be used in conjunction with suitable fittings and mechanics.
- It can be used for care purposes (CARE): Nursing beds
- It can be used in a hospital (HOSP): Hospital beds
- It can be used in treatment chairs, couches, etc.

|   |   |
|---|---|
|  |  <b>CAUTION</b>  |
|   | <p>The DC20 lifting column should only be used for the applications described above. Any other use is forbidden. Improper usage can lead to accidents or destruction of the unit. Such non-approved applications will lead immediately to the expiration of all guarantee and warranty claims on the part of the end-product manufacturer against the manufacturer.</p> |

#### Improper usage

Be sure to follow the notices below concerning improper usage. You should include them in your product manual in order to inform the users of your end product.

|   |  |
|---|--|
|  |  <b>WARNING</b>   |
|   | <p>The DC20 lifting column must not be used:</p> <ul style="list-style-type: none"> <li>• in any environment where combustible or explosive gases or vapours (e.g., anaesthesiology) may be present,</li> <li>• with pulling or pushing forces that exceed those specified on the ratings plate,</li> <li>• in a moist environment,</li> <li>• outdoors,</li> <li>• in any application that will be cleaned with an automated washing system.</li> </ul> |

|   |   |
|---|---|
|  |  <b>CAUTION</b>  |
|   | <p>The DC20 lifting column may not be operated:</p> <ul style="list-style-type: none"> <li>• by small children,</li> <li>• by frail or infirm persons without supervision, or</li> <li>• in the proximity of small children.</li> </ul> |

The DC20 lifting column can be used by children of 8 years and older, persons with reduced physical, sensory or mental capabilities, or persons with lack of experience or knowledge when they are supervised or instructed concerning the safe use of the device and when they understand the resulting risks. Do not allow children to play with this device. The cleaning and user maintenance must not be carried out by children without supervision.

- ▶ You should only use spare parts which have been manufactured or approved by DewertOkin. Only these parts will guarantee a sufficient level of safety.

## **2.2 Safety notices within the installation instruction and the operating instructions for the entire machine**

The manufacturer of the complete machine (the end product) is only permitted to operate the DC20 lifting column (by itself an incomplete machine)

- when the end product (for which the DC20 lifting column is intended) is in compliance with all protective measures specified in the Machinery Directive 2006/42/EC, and
- when the manufacturer expressly declares the compliance of the end product.

The manufacturer of the end product must create a manual for the users of that product. The safety notices in the end-product manual must be written based on the end product's risk assessment.

## **2.3 Selection and qualification of personnel**

This DC20 lifting column should only be installed into the end product by someone who has completed training in electronic motor assembly or has equivalent qualifications.

You should only install this lifting column when you are qualified to do so. Otherwise, a properly qualified person should be found for this task.

## 2.4 Notice on safety during operations

Basic safety rules must be followed in order to ensure that the end product can be continually operated in a safe manner. These rules must be observed while using the end product and while installing the drive.

These rules and safety measures can be categorized as follows:

- Construction measures before the installation (refer to the "Ensuring operational reliability during installation" section in Chapter "Installation").
- Safety fundamentals during the drive installation and during cable and wire routing (refer to the "Safety notices to observe during installation" section in the "Installation" Chapter).
- Using the drive in intermittent duty (refer to the "General information" section in the "Operating notes" chapter).
- Basic safety rules during operation (refer to the "Operating notes" Chapter).
- The creation of a manual for the end product which contains these and other safety rules.

### Creating a user's manual

The manufacturer of the end product must create a manual for the users of that product. The safety notices in the end-product manual must be written based on the end product's risk assessment.

## 2.5 Product identification

### 2.5.1 Ratings plate

A ratings plate (type label) on each DC20 lifting column specifies the exact name and serial number of the lifting column. It also states the technical specifications valid for that particular lifting column. The following illustration shows where the specifications are located on the DC20 lifting column's ratings plate.

- ▶ The ratings plate shown is an example; the specifications for your DC20 lifting column may differ from this illustration.

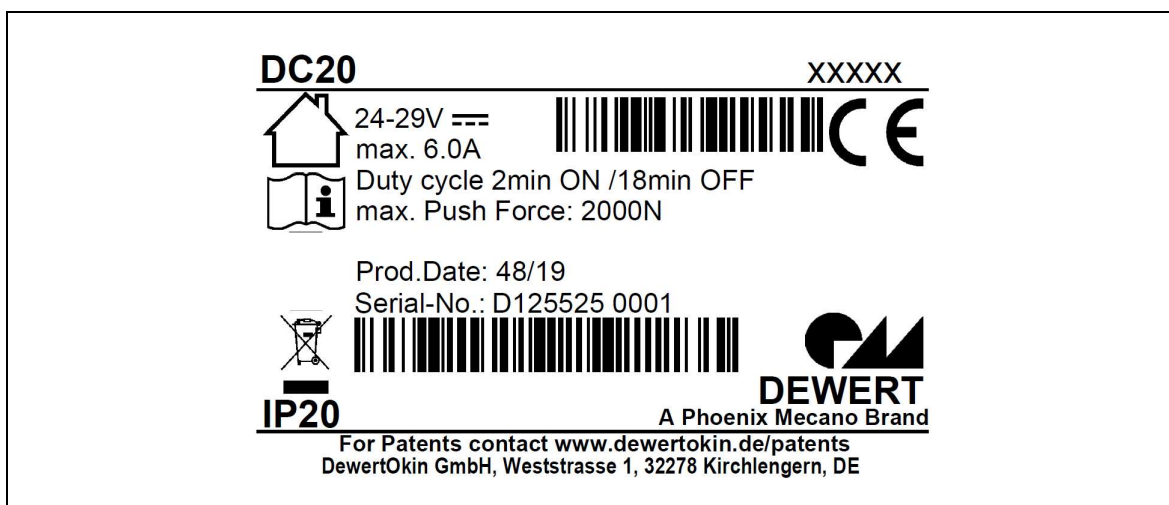





Figure 2 Ratings plate example

|   |   |
|---|---|
| DC20  | Model name                                      |
| xxxxx   | Article number                                  |
| 24 – 29V  | Input voltage                                   |
| Max. 6.0A   | Current consumption                             |
| Duty cycle: 2 min ON / 18 min OFF   | Intermittent operations: 2 minutes / 18 minutes |
| max. Push Force   | Push force                                      |
| Prod.date   | Calendar week / year                            |
| Serial No.  | Serial number for your drive                    |
| IP20  | Protection degree                               |
|  | Use in dry rooms only!                          |
|  | Read the manual!                                |
|  | Follow all special disposal instructions!       |
|  | Mark of CE conformity                           |

### 3. Possible combinations

The DC20 lifting column can be combined with other single/double drives or controllers. The following basic combinations are possible:

- a DC20 lifting column with a hand set and control unit,
- a DC20 lifting column in combination with other drives with an additional control unit or double drive.

Systems can be customized by combining the DC20 lifting column with the handset and control units as needed. Make sure that you switch off the electricity before connecting any components (connect while in a voltage-free state).

DewertOkin has separate system instruction manuals containing all information and instructions needed for these systems.

- ▶ Only a DewertOkin device should be used to control the DC20 lifting column since they have already been verified to work together.
- ▶ A control unit or a double drive is needed to operate the DC20 lifting column. A handset is also required.

**NOTICE**

Check with DewertOkin for approval concerning any special device configurations that are customized for your requirements.

## 4. Description

The DC20 lifting column is an electrically driven motor that is responsible for moving the end product in a linear direction. These adjustments are created by the in and out movement of a lifting column. The movements of the DC20 lifting column are controlled using a control unit or a double drive which is connected to a DewertOkin handset.

The different drive models vary according to their:

- electrical connection.
- dimensions and stroke,
- ▶ We reserve the right to make unannounced technical changes in the course of our continual product improvement process!

### 4.1 Components

The main components of the DC20 lifting column are the electric motor and the telescopic column. Mounting points are located at the outer end of the lifting column and at the opposite end of the drive. They are used to mount the DC20 lifting column in the end product.

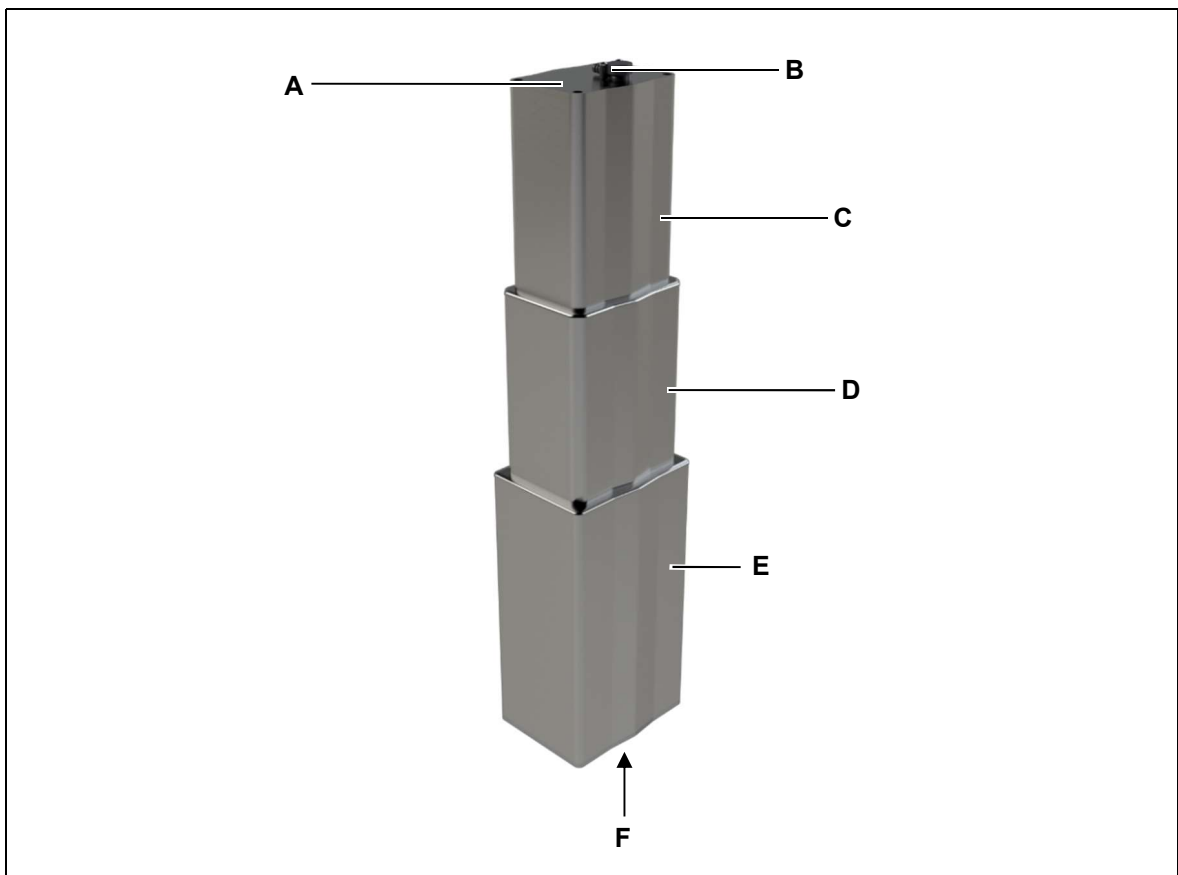

Figure 3 Main components of the DC20 lifting column

- |  |   |
|--|---|
| <b>A</b> Head of the DC20 lifting column | <b>B</b> Connecting cables (8-pin plug or LSP plug) |
| <b>C</b> Inner telescopic column         | <b>D</b> Middle telescopic column                   |
| <b>E</b> Outer telescopic column         | <b>F</b> Foot of the DC20 lifting column            |

#### 4.1.1 Connection options

The DC20 Lifting Column has different variants for the power connection:

- LS plug
- 8-pin plug

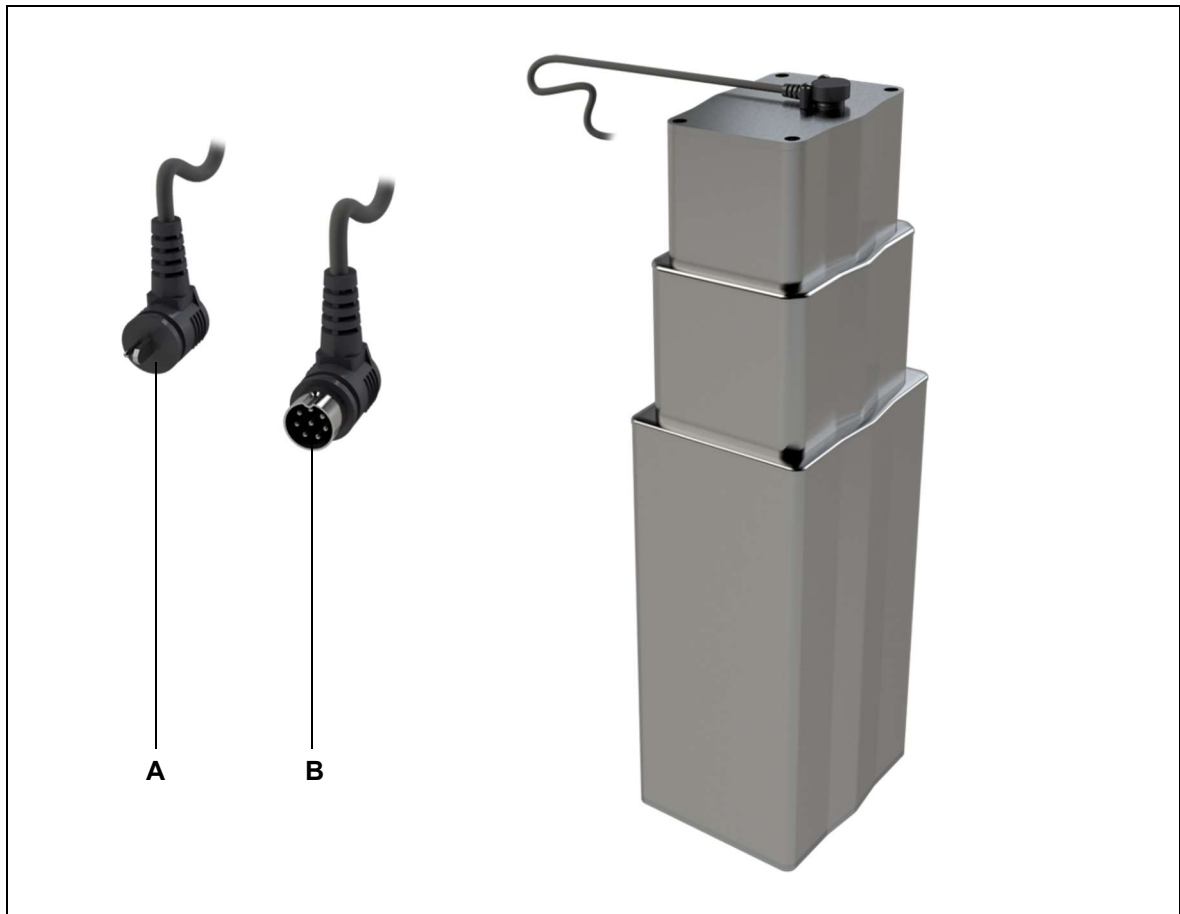

Figure 4 Variants of connectors and cables

**A** LS plug

**B** 8-pin plug

## 5. Technical specifications

|  |  |
|--|--|
| Rated voltage  | 24 V DC – 29 V DC  |
| Current consumption at rated load                              | Max. 6 A, depending on version<br>(refer to the ratings plate)         |
| Permitted push force   | Max. 2000 N depending on version<br>(refer to the ratings plate)       |
| Mode of operation <sup>1</sup> at max. rated load              | Intermittent duty: 2 min/18 min<br>(max 5 switching cycles per minute) |
| Protection class <sup>2)</sup>                                 | III  |
| Noise level  | ≤ 50 dB(A)   |
| Drive type   | Single drive   |
| Load type  | Pressure   |
| Stroke   | Max. 750 mm  |
| Adjustment speed <sup>3)</sup>                                 | Max. 22 mm/s   |
| Protection degree  | IPX4, max. IPX6  |
| <b>Dimensions and weight</b>                                   |  |
| Length x width x height  | Min. 320.5 mm x 169 mm x 135 mm  |
| Weight   | Approx. 10 kg, depending on version                                    |
| <b>Ambient conditions for operation, storage and transport</b> |  |
| Transport / storage temperature                                | From -20 °C to +50 °C<br>From -4 °F to +122 °F                         |
| Operating temperature  | From +10 °C to +40 °C<br>From +50 °F to +104 °F                        |
| Relative humidity  | From 30% to 75%  |
| Air pressure   | From 800 hPa to 1060 hPa   |
| Height   | < 2000 m   |

- 1) Mode of operation: intermittent duty 2 min./18 min. This means that after the unit is operated with its rated load for up to two minutes it must then be paused for 18 minutes. The system can malfunction if this pause is not observed!
- 2) Safety extra-low voltage
- 3) Adjustment speed: the speed at which the clevis can move under no load (the speed varies depending on the load).



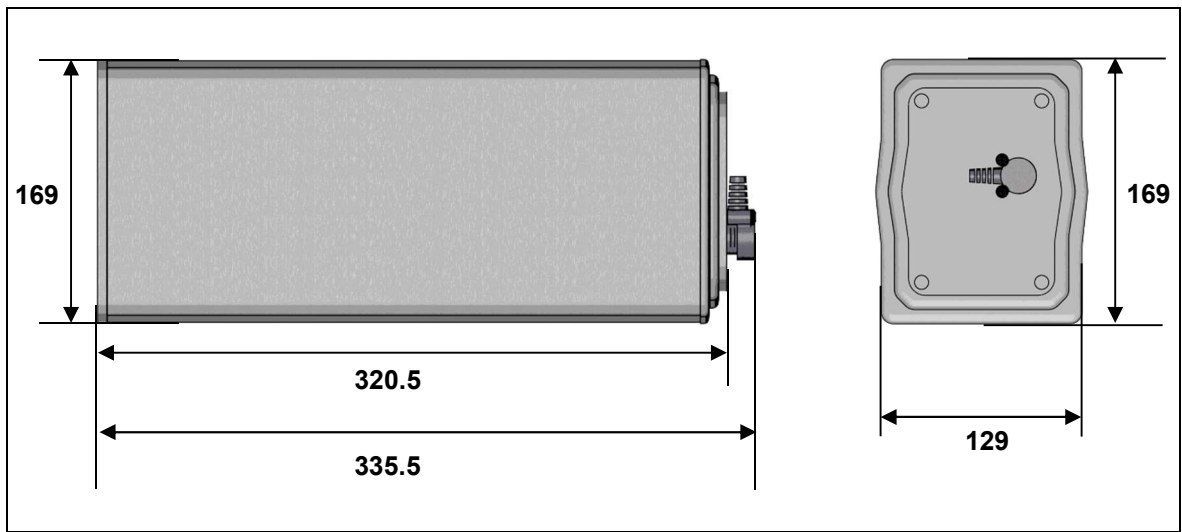

Figure 5 Dimensions of DC20 lifting column drive (in mm), minimum installation dimensions: 320.5 mm

## 6. Installation



### 6.1 Safety notices to observe during installation

Basic safety rules must be followed in order to ensure that the end product can be continually operated in a safe manner. These rules must be observed while using the end product and while installing the DC20 lifting columns.



#### 6.1.1 Ensuring operational reliability during installation

The safety and reliability of the end product containing the DewertOkin drive can be ensured by using the proper construction methods described below.

##### Avoiding fatigue fractures

|  |
|--|
|  <b>CAUTION</b>   |
| <div style="display: flex; align-items: center;">  <div> <p>DC20 lifting columns that are incorrectly installed can undergo fatigue fractures which then create a risk of injury.</p> <ul style="list-style-type: none"> <li>• Install the DC20 lifting column in the end product so that it is properly aligned. This will help prevent shear stress.</li> <li>• Do not position the DC20 lifting column at a slanted angle when installing it in the end product. A slanted angle between the intended direction of movement of the end product and the DC20 lifting column's direction will create shear stress and could lead to a fatigue fracture.</li> <li>• Be sure to install the DC20 lifting column so that it can always move freely in all operative states.</li> </ul> </div> </div> |

##### Avoiding a pinching hazard

|  |
|--|
|  <b>CAUTION</b>   |
| <div style="display: flex; align-items: center;">  <div> <p>The drive movement is executed by the telescopic column. When designing your product, you should take this into account with passive safety mechanisms and with the appropriate safety notices in your operating instructions:</p> <ul style="list-style-type: none"> <li>• Installation methods for ensuring passive safety: Install the DC20 lifting column so that none of the positions where shear and pinch hazards exist are accessible externally.</li> </ul> </div> </div> |

When preparing safety notices for the operator, Make sure that your operating instructions inform the user of these safety points.

**Avoiding an overrun of the stop point with the end product**

Your end product should contain mechanical end stops. These will limit the drive movement and significantly increase operational safety. DewertOkin recommends that you build such mechanical end stops into your end product.

The DC20 lifting column has a safety switch.

- ▶ The safety end switch shuts the DC20 lifting column down as soon as the normal end switch is passed over. The safety end switch is integrated directly into the DC20 lifting column and does not require any additional installation.
- ▶ The mechanical end stops or stroke limiters in the end product must be adjusted to fit the retracted and extended dimensions of the DC20 lifting column. Make sure that the DC20 lifting column does not reach the mechanical end stop position before it has been fully extended.

**6.2 Installation procedure**

|  |
|--|
| <b>NOTICE</b>  |
| Mount the DC20 lifting column in its unloaded position within your end product. The DC20 lifting column must either be completely retracted or extended at its end position. Damage to the DC20 lifting column can <b>only</b> be avoided if it is installed in its unloaded position. This ensures safe installation. |

**6.2.1 Installation**

Before installing the lifting column, make sure that you are observing all of the safety notices found in the "Safety notices to observe during installation" section.

|   |                |
|---|----------------|
|  | <b>CAUTION</b> |
| The plug for the connecting cable should be unplugged during the installation.      |                |

**Recommendations**

- The mounting plate of the end product should completely cover the cover plate of the DC20 lifting column. Thus, make sure that the mounting plate is properly dimensioned.
- The cable of the DC20 lifting column must be secured so that it cannot be pulled out.

| NOTICE  |  |
|---|--|
|  | <p>To avoid bending the DC20 lifting columns during operation, at least one DC20 lifting column must be mounted in a mobile position whenever two DC20 lifting columns are installed in the end product (refer to Figure 7 and Figure 6)!</p> <p>Explanation: When there are small speed differences between the two DC20 lifting columns, a relative movement of one DC20 lifting column to the other could result in shear stresses.</p> |

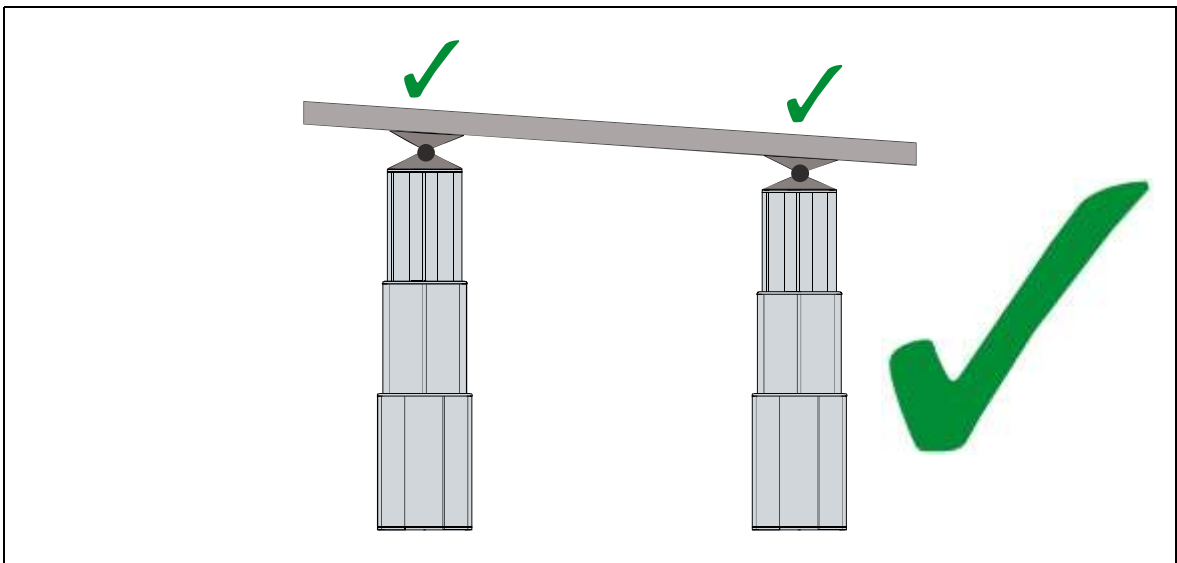

Figure 6 Movable mount – install like this: Avoidance of shear stresses due to articulated mounting of the lifting columns on both sides (schematic sketch and not to scale)

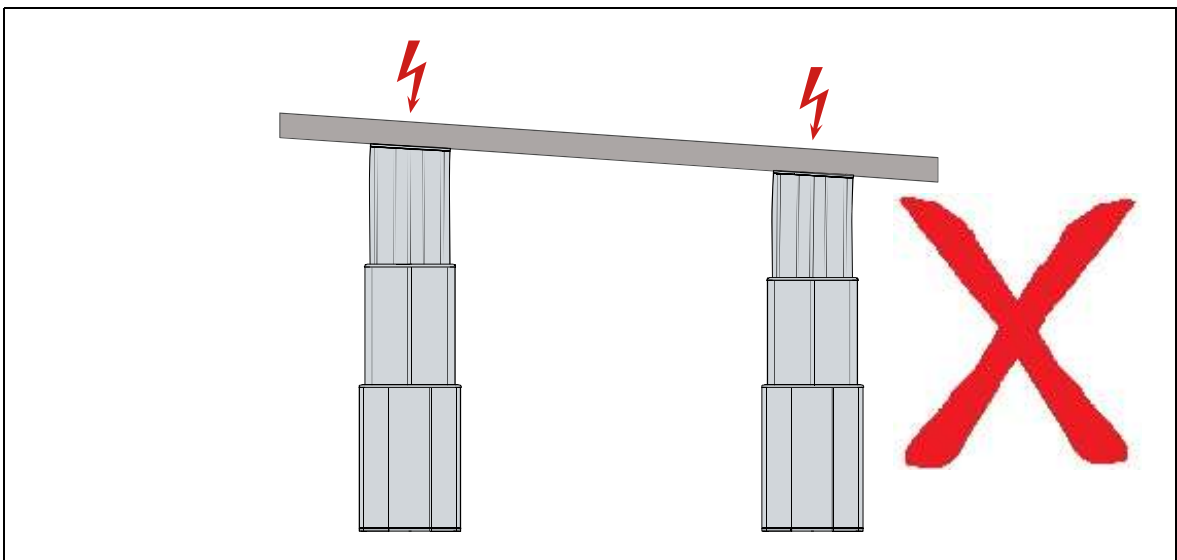

Figure 7 Fixed mount – **do not** install like this: Occurrence of shear stresses due to non-mobile (fixed) mounting of the lifting columns (schematic sketch and not to scale)

**Installation: Head and foot of the DC20 lifting column**

- ▶ Use M8x40 threaded cap screws (strength class 8.8) (as shown in Figure 8) for mounting the DC20 lifting column. The tightening torque should be between 15 and 17 Nm.
- ▶ The screws must not be loosened and re-tightened more than 2 times (only in the same thread!) to prevent damage and weakening of the screw connection.

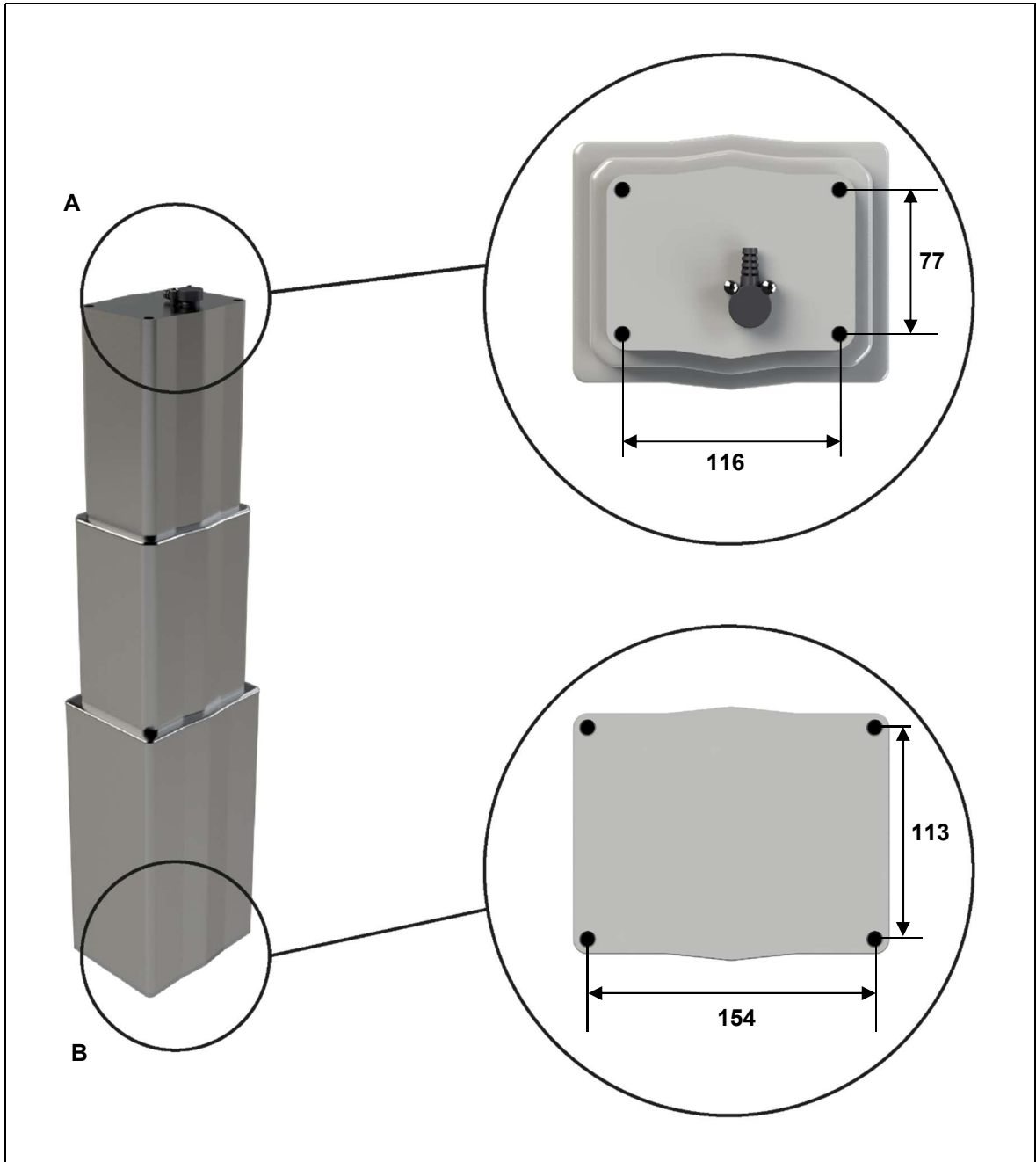



Figure 8 Mounting holes for the installation: Head and foot of DC20 lifting column (in mm)

A Head

B Foot

6.2.2 Electrical connection

|   |  |
|---|--|
|  |  <b>CAUTION</b>   |
|   | Electrical components should be connected or disconnected only when the mains power plug and the battery plug (when present) are both unplugged. |



**Routing the electrical cables**



When routing the cables, be sure that:

- the cables cannot get jammed,
- no mechanical load (such as pulling, pushing or bending) will be put on the cables, and
- the cables cannot be damaged in any way.

Fasten all cables (especially the mains cable) to the end product using sufficient strain relief and kink prevention methods. Be sure that the design of the end product prevents the mains cable from coming into contact with the floor during transport.

6.2.3 Dismantling the DC20 lifting column

|   |  |
|---|--|
|  |  <b>CAUTION</b>   |
|   | Electrical components should be connected or disconnected only when the mains power plug and the battery plug (when present) are both unplugged. |

|   |  |
|---|--|
|  |  <b>CAUTION</b>   |
|   | Work on the DC20 lifting column while it is in its unloaded position. Only in this way can you be sure to avoid any risks of crushing or injury. |

► Certain details may change because of technical changes.



- 1 Move your product into a position where it is supporting no load.
- 2 Remove the connecting cable from the controller or double drive.
- 3 If multiple drives are connected electrically, they should be disconnected from each other.

|   |   |
|---|---|
|  | <b>NOTICE</b>   |
|   | Support the DC20 lifting column; the DC20 lifting column is released immediately after the screws are loosened. |

- 4 Remove the DC20 lifting column from the end product.

## 7. Operating notes

The factual information contained within may be used when you are creating the end-product manual. The installation instructions do not contain all information required for the safe operation of the end product. They only describe the installation and operation of the DC20 lifting column as a partially assembled piece of machinery.

|   |  |
|---|--|
|  |  <b>CAUTION</b>   |
|   | When creating the operating instructions, remember that the installation instructions are intended for qualified specialists and are not for typical users of the end product. |

### 7.1 General information



- ▶ Only a DewertOkin device should be used to control the DC20 lifting column since they have already been verified to work together.

#### Power-on time / intermittent operations

The DC20 lifting column has been designed for intermittent operations. Intermittent operation is an operational mode where the DC20 lifting column must pause after a specified maximum period of operation (power-on time). This protects it from overheating. Extreme overheating can cause a malfunction.



- ▶ The ratings plate specifies the maximum power-on time and the required pause intervals.

#### Avoiding electrical risks





|   |  |
|---|--|
|  |  <b>WARNING</b>   |
|   | Make sure that all live (current-carrying) parts of the drive system and power supply cannot be touched. In particular, be sure that unused power and control unit connections are covered adequately. |

#### Avoiding cable damage

Be sure that your operating instructions inform the user about the possible cable risks.

|   |  |
|---|--|
|  |  <b>CAUTION</b>   |
|   | The cables (particularly the connecting cable) should not be run over. In order to prevent injuries or damage to the DC20 lifting column, no mechanical strain should be placed on the cables. |



**Switching off the DC20 lifting column**

|   |   |  |   |
|---|---|--|---|
|    | <table border="1"><tr><td data-bbox="379 421 1436 495"> <b>CAUTION</b></td></tr><tr><td data-bbox="379 495 1436 609">In order to shut off the DC20 lifting column, unplug the mains power plug and the battery plug (when present). The power plug (of the control unit or double drive) must always be accessible during operations so that emergency shut-off is possible.</td></tr></table> |  <b>CAUTION</b> | In order to shut off the DC20 lifting column, unplug the mains power plug and the battery plug (when present). The power plug (of the control unit or double drive) must always be accessible during operations so that emergency shut-off is possible. |
|  <b>CAUTION</b>  |   |  |   |
| In order to shut off the DC20 lifting column, unplug the mains power plug and the battery plug (when present). The power plug (of the control unit or double drive) must always be accessible during operations so that emergency shut-off is possible. |   |  |   |



## 8. Troubleshooting

This chapter describes troubleshooting methods for fixing problems. If you experience an error that is not listed in this table, please contact your supplier.

|   |  |
|---|--|
|  |  <b>CAUTION</b>                       |
|   | <p>Only qualified specialists who have received electrician training should carry out troubleshooting and repairs.</p> |

| Problem  | Possible cause   | Solution  |
|--|--|---|
| The handset or drive system is not functioning.          | There is no mains supply voltage.  | Connect the mains power.  |
|  | The hand switch or drive system is defective.  | Please contact your supplier or sales agent.                      |
| The DC20 lifting column can suddenly no longer be moved. | Possibly the thermal circuit breaker on the transformer has been triggered.              | The drive system should be allowed to pause for 20 to 30 minutes. |
|  | The thermal fuse on the transformer may have been triggered.                             | Please contact your supplier or sales agent.                      |
|  | The unit's fuse may have been triggered.   | Please contact your supplier or sales agent.                      |
|  | There is no mains supply voltage.  | Connect the mains power.  |
|  | A lead-in connection has been interrupted (mains power, hand switch or auxiliary drive). | Check the cables and reinsert them, if required.                  |

## 9. Maintenance

- ▶ You should only use spare parts which have been manufactured or approved by DewertOkin. Only these parts will guarantee a sufficient level of safety.

### 9.1 Maintenance

| Type of check   | Explanation  | Time interval   |
|---|--|---|
| Check the function and safety of the electrical system.                             | A qualified electrician should carry out this inspection. (Refer to the "Electrical connection" section in the "Installation" Chapter.)                      | Periodic inspections can be carried out at intervals based on the risk assessment which you conduct for your end product. |
| Look over the housing periodically for any signs of damage.                         | Check the housing for breaks or cracks. The IP-class protection will be impaired by any breakage or cracks.  | At least every six months.  |
| Look over the plug-in connections and electrical access points for signs of damage. | Check that all electrical cables and connections are firmly seated and correctly positioned.   | At least every six months.  |
| Look over the cables for any signs of damage.                                       | Check the connecting cables for pinching or shearing. Also check the strain relief and kink protections mechanisms, in particular after any mechanical load. | At least every six months.  |
| Periodic functional test of the end switches.                                       | Move the drive to the end positions in order to test the end switches.   | At least every six months.  |

## 9.2 Cleaning and care

The DC20 lifting column was designed so that it would be easy to clean. Its smooth surfaces simplify the cleaning process.

**NOTICE**

Never clean the DC20 lifting column in an automated washing system or with a high-pressure cleaner. Do not allow fluids to penetrate it. Damage to the system could result.

- 1 Always disconnect the mains power plug of the control unit or double drive (and the battery plug if present) before you start to clean the unit!
- 2 Clean the DC20 lifting column when it is retracted. Use a damp cloth.
- 3 Be sure that you do not damage the DC20 lifting column's connecting cable.

**NOTICE**

Do not use a cleanser that contains benzene, alcohol or similar solvents.

## 10. Disposal

### 10.1 Packaging material

The packaging material should be sorted into recyclable components and then disposed of in accordance with the appropriate national environmental regulations (in Germany according to the recycling law KrWG from 01.06.2012; internationally according to the EU Directive 2008/98/EC (Waste Framework Directive WFD as of 12.12.2008)).

### 10.2 Components of the lifting column

The DC20 lifting column consists of electronic components, cables and metal and plastic parts. You should observe all corresponding national and regional environmental regulations when disposing of the lifting column.

The disposal of the product is regulated in Germany by Elektro-G, internationally by the EU Directive 2012/19/EC (WEEE), or by any applicable national laws and regulations.



The DC20 lifting column should not be disposed of with normal household waste!

## Einbauerklärung

nach Anhang II der EU-Maschinenrichtlinie  
2006/42/EG

Der Hersteller

## Declaration of Incorporation

According to Appendix II of the EU Machinery  
Directive 2006/42/EC

The manufacturer:

DewertOkin GmbH  
Weststraße 1  
32278 Kirchlengern  
Deutschland - Germany

erklärt hiermit, dass nachstehend beschriebene  
unvollständigen Maschinen

*declares that the incomplete machines described  
below*

### DC20

die folgenden grundlegenden Anforderungen der  
Richtlinie Maschinen (2006/42/EG) erfüllt:

*complies with the following basic requirements of the  
Machinery Directive (2006/42/EC):*

Abschnitt:

*Sections:*

1.1.3; 1.3.3; 1.3.4; 1.3.7; 1.5.1; 1.5.2; 1.5.5; 1.5.6; 1.5.7; 1.5.8; 1.5.9; 1.5.10; 1.5.13

Die unvollständige Maschine darf erst dann in Be-  
trieb genommen werden, wenn festgestellt wurde,  
dass die Maschine, in die die unvollständige Ma-  
schine eingebaut werden soll, den Bestimmungen  
der Richtlinie Maschinen (2006/42/EG) entspricht.

*You may only operate this incomplete machine after  
you have confirmed that the end product (into which  
this machine will be installed) complies with the  
Machinery Directive 2006/42/EC.*

Der Hersteller verpflichtet sich, die speziellen Unter-  
lagen zur unvollständigen Maschine einzelstaatli-  
chen Stellen auf begründetes Verlangen elektronisch  
zu übermitteln. Die zur Maschine gehörenden  
speziellen technischen Unterlagen nach Anhang VII  
Teil B wurden erstellt.

*On reasonable request, the manufacturer is obliged  
to send the special documentation accompanying the  
partially completed machinery in electronic form to  
the appropriate national institution. The special  
technical documents corresponding to the machine  
have been created according to Appendix VII, part B.*

Für die Zusammenstellung der technischen Unter-  
lagen ist bevollmächtigt: DewertOkin GmbH  
Weststraße 1  
32278 Kirchlengern  
Tel.: 05223 979-0  
Deutschland - Germany

*For preparation of the technical documentation is  
authorized:* DewertOkin GmbH  
Weststraße 1  
32278 Kirchlengern  
Tel.: 05223 979-0  
Deutschland - Germany

Kirchlengern, Germany 13 December 2019



Dr.-Ing. Josef G. Groß  
Geschäftsführer / Managing Director

## EG-Konformitätserklärung

Nach Anhang IV der EMV-Richtlinie 2014/30/EU

Nach Anhang IV der EU-Niederspannungsrichtlinie 2014/35/EU

Nach Anhang VI der RoHS-Richtlinie 2011/65/EU (inkl. Delegierte Richtlinie (EU) 2015/863)

Der Hersteller

## EU Declaration of Conformity

*In compliance with Appendix IV of the EMC-Directive 2014/30/EU*

*In compliance with Appendix IV of the LVD-Directive 2014/35/EU*

*In compliance with Appendix VI of the EU RoHS Directive 2011/65/EU (incl. Commission delegated Directive (EU) 2015/863)*

*The manufacturer*

DewertOkin GmbH  
Weststraße 1  
32278 Kirchlegern  
Deutschland - Germany

erklärt hiermit, dass das Produkt

*declares that the following product*

### DC20<sup>1)</sup>

die Anforderungen folgender EG-Richtlinien erfüllt:

*meets the requirements of the following EU directives:*

**Richtlinie über elektromagnetische Verträglichkeit 2014/30/EU**

**Electromagnetic Compatibility Directive 2014/30/EU**

**Niederspannungsrichtlinie 2014/35/EU**

**Low Voltage Directive 2014/35/EU**

**DELEGIERTE RICHTLINIE (EU) 2015/863 DER KOMMISSION vom 31. März 2015 zur Änderung von Anhang II der Richtlinie 2011/65/EU des Europäischen Parlaments und des Rates hinsichtlich der Liste der Stoffe, die Beschränkungen unterliegen.**

**COMMISSION DELEGATED DIRECTIVE (EU) 2015/863 of 31 March 2015 amending Annex II to Directive 2011/65/EU of the European Parliament and of the Council as regards the list of restricted substances.**

Angewendete Normen

*Applied standards:*

- EN 55014-1:2006/A1:2009/A2:2011
- EN 55014-2:1997/A1:2001/A2:2008
- EN 61000-3-2:2014
- EN 61000-3-3:2013
- EN 62233:2008

Konstruktive Änderungen, die Auswirkungen auf die in der Montageanleitung angegebenen technischen Daten und den bestimmungsgemäßen Gebrauch haben, das Produkt also wesentlich verändern, machen diese Konformitätserklärung ungültig!

*This declaration of conformity is no longer valid if constructional changes are made which significantly change the drive system (i.e., which influence the technical specifications found in the instructions or the intended use)!*



Kirchlegern, Germany 13 December 2019

Dr.-Ing. Josef G. Groß  
Geschäftsführer / Managing Director

<sup>1)</sup> mit DewertOkin-Steuerung / *with DewertOkin control unit*

## Additional information

### DC20 drive system

The following standards and norms were used in the versions with at least IPX4 and higher in according to

- EN 60601-1:2006 + A1:2013, IEC 60601-1:2005 + A1:2012 (short description: Edition 3.1), Medical electrical equipment.
- EN 60601-1-2:2015, IEC 60601-2-2:2014 (short description: Edition 4.0), EMC

|   |  |
|---|--|
| IEC/EN60601-1, Section 4                    | General requirements   |
| IEC/EN60601-1, Section 6                    | Classification   |
| IEC/EN60601-1, Section 7.1                  | Labelling – general  |
| IEC/EN60601-1, Section 7.2                  | Labelling – inscriptions   |
| IEC/EN60601-1, Abschnitt 8                  | Protection against electrical danger                             |
| IEC/EN60601-1, Section 11.1                 | Overheating protection   |
| IEC/EN60601-1, Section 11.2                 | Fire prevention  |
| IEC/EN60601-1, Section 11.3                 | Design requirements for fire-resistant housing                   |
| IEC/EN60601-1, Section 13                   | Dangerous situations and error conditions                        |
| IEC/EN60601-1, Section 16.6                 | Leakage current  |
| IEC/EN60601-1, Section 17                   | Electromagnetic compatibility                                    |
| IEC/EN60601-2-52,<br>Section 201.11.6.5.101 | Protection against water ingress: only applied for at least IPX4 |
| IEC/EN60601-2-52,<br>Section 201.9.8.3.2    | Static load  |











DewertOkin GmbH  
Weststrasse 1  
Kirchlengern 32278, Germany  
Tel: +49 (0)5223/979-0  
Fax.: +49 (0)5223/75182  
<http://www.dewertokin.de>  
[Info@dewertokin.de](mailto:Info@dewertokin.de)

ID No.: 92299